



Yudian (H.K.) Automation Technology Co. Ltd.

Website: <http://www.yudian.us> <http://www.yudian.com.hk>

Email: sales@yudian.com.hk

Tel: +852-2770 8785 Fax: +852-2770 8796

AI-501

INTELLIGENT INDICATING/ALARMING INSTRUMENT

Operation Instruction

CONTENTS	Page
MAIN FEATURES.....	2
ORDERING CODE.....	3
TECHNICAL SPECIFICATION.....	5
FRONT PANEL AND OPERATION.....	6
PARAMETER AND SETTING.....	7
TERMINAL LAYOUT AND WIRING.....	9



Yudian (H.K.) Automation Technology Co. Ltd.

Website: <http://www.yudian.us> <http://www.yudian.com.hk>

Email: sales@yudian.com.hk

Tel: +852-2770 8785 Fax: +852-2770 8796

MAIN FEATURES:

- Programmable and modular inputs, supporting multiple input types of thermocouples, RTDs, voltage/current and two-wire transmitters. Suitable for measuring and displaying temperature, pressure, flow, level, humidity, etc with measurement accuracy of 0.3% full scale.
- Dual display windows, convenient to set parameters and alarm points. Various dimensions are selectable.
- Supports up to 4 loops of alarms including 2 loops of high limit alarms plus 2 loops of low limit alarms. Alarms can be outputted to different relays or share one.
- With functions of digital calibrating, digital filtering, and thermocouple cold junction auto compensating, it is free of maintenance and easy operated.
- Supports RS485 communication interface, able to communicate with computers.
- Retransmission function, cooperating with X3 high precision current output module (0.2%FS), can retransmit temperature with accuracy of 0.3%FS.
- High quality and performance hardware design, using high performance tantalum capacitor or ceramic capacitor. Compared to competing models, it consumes less electricity, experiences less temperature shifting, provides higher stability and reliability and can work in a wider range of temperature. The power and I/O terminals have passed the anti-interference test of 4KV/5KHz burst of pulses.
- Universal 100-240V power supply, with thunderbolt proof and 10 seconds protection from connecting to 380VAC by mistake.

ORDERING CODE:

The ordering code of AI-501 is made up of 8 parts, for example:

AI-501 A N X3 L5 N S4 — 24VDC
 ① ② ③ ④ ⑤ ⑥ ⑦ ⑧

This means an instrument with ① model AI-501, ② dimension A (96x96mm), ③ no module in MIO (multiple input/output) slot, ④ X3 linear current output module installed in OUP (main output) slot, ⑤ L5 dual relay output module in ALM (alarm) slot, ⑥ no module in AUX (auxiliary output), ⑦ RS485 communication interface module S4 in COMM (communication) slot, and ⑧ 24VDC power supply.

The meanings of the 8 parts of ordering code are as below:

① Shows the model of instrument

AI-501 Indicating/Alarming Instrument with measurement accuracy of 0.3%FS

② Shows the front panel dimension:

Size	Front Panel Width X Height	Cut Out Width X height	Depth Behind	Light Bar
A	96 X 96 mm	92 X 92 mm	100 mm	No
A2	96 X 96 mm	92 X 92 mm	100 mm	25 segments and 4 levels
B	160 X 80 mm	152 X 76mm	100 mm	No
C	80 X 160 mm	76 X 152mm	100 mm	No
C3	80 X 160 mm	76 X 152mm	100 mm	50 segments and 2 levels
D	72 X 72 mm	68 X 68 mm	95 mm	No
E	48 X 96 mm	45 X 92 mm	100 mm	No
F	96 x 48 mm	92 X 45 mm	100 mm	No
D2	48 X 48 mm	45 X 45 mm	95 mm	No

③ Shows the module types of multiple input/output (MIO). Selectable modules are as follows:

V5/V10 Isolated 5 /12 /10 /24VDC voltage output, can supply power for external transmitter or transducer.

V12 / V24

I4 4-20mA or 0-20mA analogue input interface with 24VDC/50mA power supply, can directly connect to two-wire transmitter

I7 0~5A current input module, can measure 5A alternating current directly.

I8 0~500V voltage input module, can measure 0~500VAC alternating voltage directly

④ Shows the module types of main output (OUP):

Installing X3 or X5 (isolated type) current output module can retransmit process value (PV).

⑤ Shows the module type of alarm output (ALM):

Can output alarms by installing L1, L2, or L4 relay output module or L5 dual relay output module.

⑥ Shows the module type of auxiliary output (AUX):

Can output alarms by installing L1, L2, L4 or L5 relay output module.

⑦ **Shows the module type of communication (COMM):**

Installing S or S4 module can communicate with RS485 interface.

⑧ **Shows type of power supply:**

Null indicates 100~240VAC power supply, and "24VDC" indicates 20~32VDC/AC power.

Note 1: 4~20mA or 0~20mA standard current signal can be inputted by converting to 1~5V/0~5V voltage signal with a 250 ohm resistor or installing I4, module in MIO slot. I4 can supply 24VDC power to 2-wire transmitter.

Note 2: D dimension instruments have no MIO slot, and its COMM and ALM share the same slot and can't be installed at the same time. Its ALM only, support AL1 single loop alarm. D2 dimension instruments have only OUP slot and COMM / AUX slot.

Note 3: Current module X3 and RS485 communication module S share the same power supply in the instrument, and are not electric isolated to each other. Therefore, if X3 current module is installed in OUP slot and RS485 communication is need at the same time, then RS485 communication module should be S4 which itself has isolated power supply.

Note 4: The instrument applies the technology of auto zero and digital calibration, and is free of maintenance. If the error exceeds certain range, generally, cleaning and drying the inside of the instrument can fix it. If not, send the instrument back to the factory to examine and repair.

Note 5: Free repair and maintenance will be given in 36 months since the delivery. In order to get full and correct repair, write the phenomena and causes of the malfunction of the instrument.

TECHNICAL SPECIFICATION:

- **Input type :**
 - Thermocouple: K, S, R, E, J, N
 - Resistance thermometer: Pt100, Cu50
 - Linear voltage: 0~5V, 0~1V, 0~500mV, 0~100mV, 0~60mV, 0~20mV, 100~500mV, 0~10V, 0~20V,
 - Linear current (should connect a external resistor or install I4 module in MIO slot): 0~20mA, 4~20mA
 - Linear resistor: 0~80 ohm, 0~400 ohm
 - Alternating current: 0~5A
 - Alternating voltage: 0~500VAC
- **Measurement range :**
 - K(0~+1300°C), S(0~1700°C), R(0~1700°C), E(0~1000°C), J(0~1200°C), N(0~1300°C),
 - Pt100(-200~+800°C), Cu50(-50~+150°C)
- **Linear input :**
 - 9990~+30000 unit defined by user
- **Measurement accuracy :**
 - 0.3%FS±1
- **Temperature display resolution :**
 - 0.1°C for K, E, J, N, Pt100 and 1°C for S, R
- **Temperature shift :**
 - ≤0.015%FS/°C (typical value is 75ppm/°C)
- **Electromagnetic compatibility (EMC) :**
 - IEC61000-4-4, ± 4KV/5KHz; IEC61000-4-5, 4KV
- **Retransmission :**
 - When X3 or X5 current module is installed in OUPF slot, process value (PV) can be retransmitted to standard current with maximum load resistor 500 ohm.
- **Alarm function :**
 - High limit, low limit, second high limit and second low limit
- **Isolation withstanding voltage :**
 - Between power, relay contact or signal terminals ≥2300VDC; between isolated electroweak signal terminals ≥600VDC
- **Power supply :**
 - 100~240VAC, -15%, +10% / 50-60Hz; 24VDC / AC, -15%, +10%
- **Power consumption:** ≤5W
- **Operating Ambient :** Temperature -10~+60°C; humidity ≤90%RH
- **Front panel dimension:** 96×96mm, 160×80mm, 80×160mm, 48×96mm, 96×48mm, 72×72mm, 48×48mm
- **Panel cutout dimension:** 92×92mm, 152×76mm, 76×152mm, 45×92mm, 92×45mm, 68×68mm, 45×45mm
- **Depth behind mounting surface:** ≤100mm





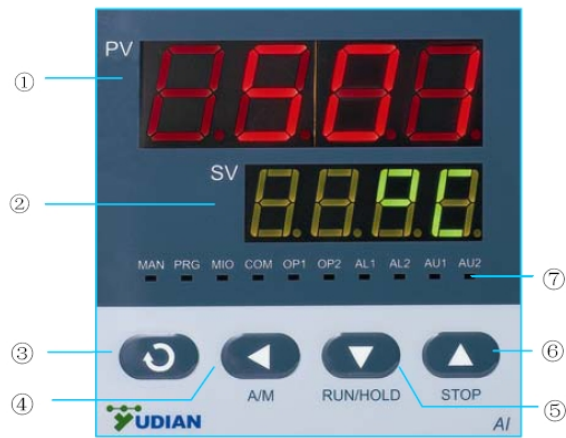







FRONT PANEL AND OPERATION:

- ① Upper display window, displays PV, or code of a parameter
- ② Lower display window, displays alarming code or parameter value
- ③ Setup key, for accessing parameter tables, and confirming change.
- ④ Data shift key
- ⑤ Data decrease key
- ⑥ Data increase key



⑦ Indicator lamps: OP1 and OP2 indicate the status of current retransmission. AL1, AL2, AU1 and AU2 indicate the I/O actions of the corresponding modules.

Basal display status : When power on, the upper display window of the instrument shows the process value (PV). This status is called basal display status. When the input signal is out of the measurable range (for example, the thermocouple or RTD circuit is break, or input specification sets wrong), the upper display window will alternately display “orAL” and the high limit or the low limit of PV.

Parameter Setting: In basal display status, press  and hold for about 2 seconds, can access Field Parameter Table. If the parameter lock “Loc” isn’t locked (Loc=0), we can modify the value of parameters by   or . Press  key to decrease the value,  key to increase the value, and  key to move to the digit expected to modify. Keep pressing  or , the speed of increasing or decreasing value get quick. Pressing  can go to the next parameter. Press  and hold can return to the preceding parameter. Press  (don’t release) and then press  simultaneously can escape from the parameter table. The instrument will escape automatically from the parameter table if no key is pressed within 30 seconds. Setting Loc=808 and then press can access System Parameter Table.

PARAMETER AND SETTING

- Field parameter table (Press  and hold for 2 seconds to access)

Code	Name	Description	Setting Range
HIAL	High limit alarm	Alarm on when PV (Process Value) >HIAL; Alarm off when PV<HIAL-AHYS	-9990~ 30000
LoAL	Low limit alarm	Alarm on when PV<LoAL; alarm off when PV>LoAL+AHYS	
HdAL	Second high limit alarm	Alarm on when PV>HdAL; alarm off when PV<HdAL-AHYS	
LdAL	Second low limit alarm	Alarm on when PV<LdAL; alarm off when PV>LdAL+AHYS	
Loc	Parameter lock	0~3: allowed to modify field parameters; 4~255: can only modify "Loc"; setting Loc=808 and then pressing can access system parameter table.	0~9999

- System parameter table (set Loc=808 and then press  to access)

AHYS	Alarm hysteresis	Avoid frequent alarm on-off action because of the fluctuation of PV. For temperature alarm, it is recommended to be 0.5~2°C.	0~200																														
AOP	Alarm output assignment	<table border="1"> <thead> <tr> <th>Alarm Output to</th> <th>LdAL (x 1000)</th> <th>HdAL (x100)</th> <th>LoAL (x10)</th> <th>HIAL (x1)</th> </tr> </thead> <tbody> <tr> <td>None</td> <td>0</td> <td>0</td> <td>0</td> <td>0</td> </tr> <tr> <td>AL1</td> <td>1</td> <td>1</td> <td>1</td> <td>1</td> </tr> <tr> <td>AL2</td> <td>2</td> <td>2</td> <td>2</td> <td>2</td> </tr> <tr> <td>AU1</td> <td>3</td> <td>3</td> <td>3</td> <td>3</td> </tr> <tr> <td>AU2</td> <td>4</td> <td>4</td> <td>4</td> <td>4</td> </tr> </tbody> </table> <p>Example: AOP = <u> 3 </u> <u> 3 </u> <u> 0 </u> <u> 1 </u> LdAL HdAL LoAL HIAL</p> <p>It shows that HdAL and LdAL are sent to AU1, LoAL has no output, HIAL is sent to AL1.</p> <p>Note : Installing L5 dual relay output module in ALM or AUX can implement AL2 or AU2 alarm.</p>	Alarm Output to	LdAL (x 1000)	HdAL (x100)	LoAL (x10)	HIAL (x1)	None	0	0	0	0	AL1	1	1	1	1	AL2	2	2	2	2	AU1	3	3	3	3	AU2	4	4	4	4	0~4444
Alarm Output to	LdAL (x 1000)	HdAL (x100)	LoAL (x10)	HIAL (x1)																													
None	0	0	0	0																													
AL1	1	1	1	1																													
AL2	2	2	2	2																													
AU1	3	3	3	3																													
AU2	4	4	4	4																													
INP	Input specification	<table border="1"> <thead> <tr> <th>INP</th> <th>Input type</th> <th>INP</th> <th>Input type</th> </tr> </thead> <tbody> <tr> <td>0</td> <td>K</td> <td>20</td> <td>CU 50</td> </tr> <tr> <td>1</td> <td>S</td> <td>21</td> <td>PT 100</td> </tr> <tr> <td>2</td> <td>R</td> <td>26</td> <td>0~80 omhs</td> </tr> <tr> <td>3</td> <td>SPARE</td> <td>27</td> <td>0~400 omhs</td> </tr> <tr> <td>4</td> <td>E</td> <td>28</td> <td>0~20mV</td> </tr> <tr> <td>5</td> <td>J</td> <td>29</td> <td>0~100mV</td> </tr> </tbody> </table>	INP	Input type	INP	Input type	0	K	20	CU 50	1	S	21	PT 100	2	R	26	0~80 omhs	3	SPARE	27	0~400 omhs	4	E	28	0~20mV	5	J	29	0~100mV	0~37		
INP	Input type	INP	Input type																														
0	K	20	CU 50																														
1	S	21	PT 100																														
2	R	26	0~80 omhs																														
3	SPARE	27	0~400 omhs																														
4	E	28	0~20mV																														
5	J	29	0~100mV																														

		6	SPARE	30	0~60mV	
		7	N	31	0~500mV	
		8~13	SPARE	32	100~500mV	
		14	SPARE	33	1~5V	
		15	4~20mA, (I4 module need)	34	0~5V	
		16	0~20mA(I4 module need)	35	0~10V	
		16	0~5A (I7 module need)	36	2~10V	
		16	0~500VAC(I8 module need)	37	0~20V	
dPt	Resolution	Four formats (0, 0.0, 0.00, 0.000) are selectable For thermocouples or RTD inputs, only 0 and 0.0 are selectable, and the internal resolution is 0.1. For linear input, if the value of PV or any parameter is probably greater than 9999, format 0.000 is recommended.				0 / 0.0, / 0.00, / 0.000
SCL	Signal scale low limit	Define scale low limit of input signal. It is also the scale of the low limit of retransmission output. For example, to transform 1~5V input signal into process value of 0~200.0, we shall set dPt=0.0, SCL=0, SCH=200.0				-9999~ +30000
SCH	Signal scale high limit	Define scale high limit of input signal. It is also the scale of the high limit of retransmission output. For example, to transform 0~5V input signal into process value of 1000~2000, we shall set dPt=0, SCL=1000, SCH=2000.				
Scb	Input shift adjustment	Scb is used to compensate the error produced by sensor or input signal. $PV_{after_compensation} = PV_{before_compensation} + Scb$. For example, for the same input signal, if the measured temperature PV is 500.0°C when Scb=10.0, then PV should be 510.0°C.				-1999~ +4000
FILt	Input filter	The value of FILt will determine the ability of filtering noise. When a large value is set, the measurement input is stabilized but the response speed is slow. Generally, it can be set to 1 to 3. If great interference exists, then you can increase parameter "FILt" gradually to make momentary fluctuation of measured value less than 2 to 5. When the instrument is being metrological verified, "FILt" s can be set to 0 or 1 to shorten the response time.				0~40
OPt	Output type	0-20: 0~20mA linear current retransmission output; 4-20: 4~20mA linear current retransmission output.				
Addr	Communication address	In the same communication line, different instrument should be set to different address.				0~80
bAud	Baud rate	The range of baud rate is 1200 ~ 19200 bit/s. Can be set to 4800, 9600 or 19200.				0~ 19200

Wiring graph for D dimension (72mmX72mm) instruments

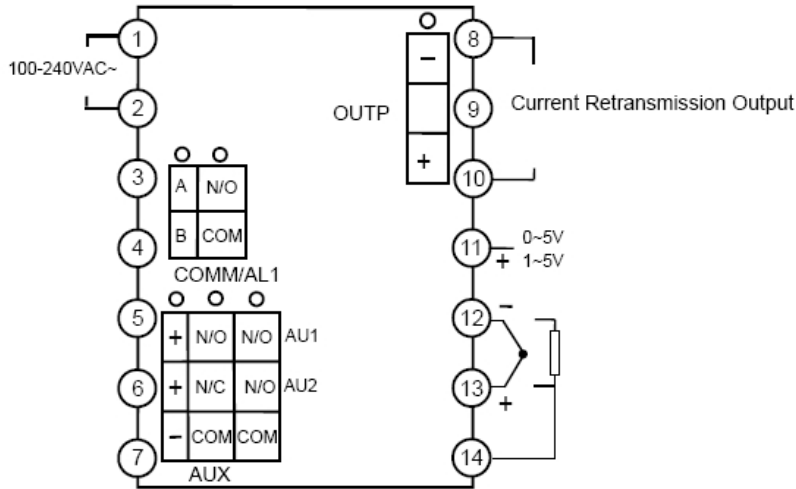

Note:

- Linear voltage signal of range below 500mV should be inputted from terminals 13+ and 12-,
- Signal of 0~5V, 1~5V or 0~10V should be inputted from terminals 11+ and 12-.
- 4~20mA linear current signal can be converted to 1~5V voltage signal with a 250 ohm resistor and inputted from terminals 11+ and 12-.

Wiring graph for D2 dimension (48mmX48mm) instruments

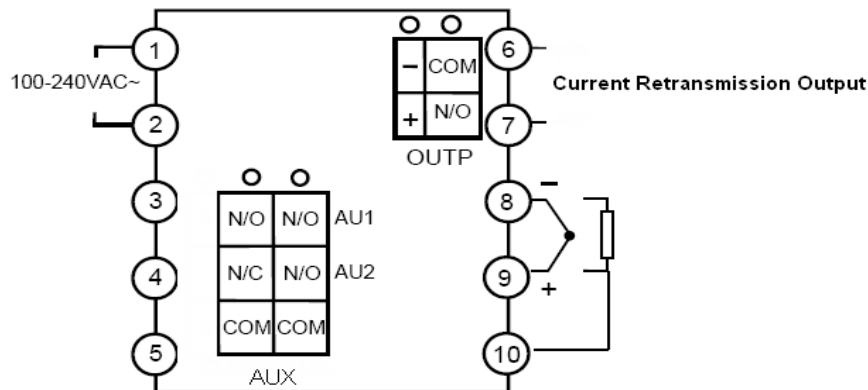

Note:

- Linear voltage signal of range below 500mV should be inputted from terminals 8- and 9+,-,
- D2 dimension not support 0~5V or 1~5V input. However, 0~5V or 1~5V can be converted to 0~500mV or 100~500mV by connecting external resistor (it belong to custom made order, please contact our sales or agent)
- 4~20mA linear current signal can be converted to 100~500mV voltage signal with a 25 ohm resistor and inputted from terminals 8- and 9+.